

## "UBDR" UNDERBAR BAR DRAINS

### 12" Long - 48" Long

#### FEATURES:

- 18GA Stainless Steel Construction
- Type 300 Stainless Steel With #4 Polish, Satin Fi
- Removable Slotted Grate With Finger Holes
- Drain Pipe 1" Long With 1/4" MPT Threads

#### SPECIFICATIONS:

- Trough: 18GA Type 300 Stainless Steel
- Grate: 18GA Type 300 Stainless Steel
- Drain Pipe: 1/4" MPT Outside Threads

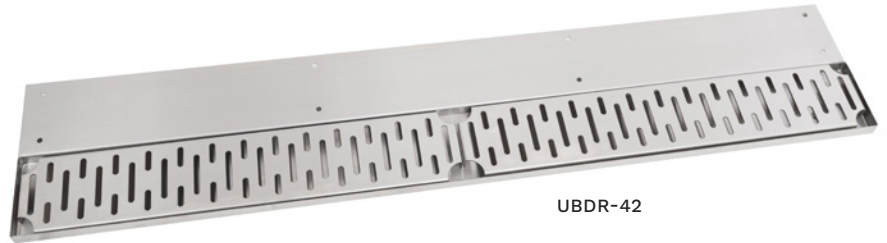

UBDR-42

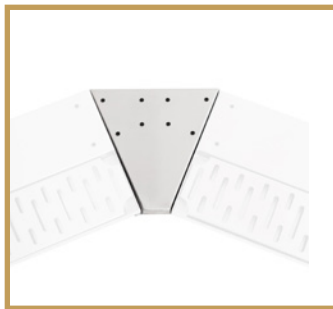

UBDR-45-IC

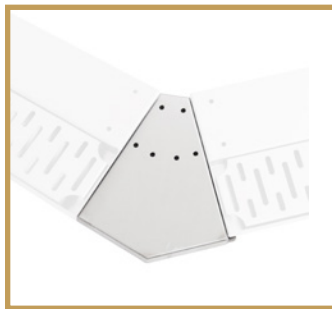

UBDR-45-OC

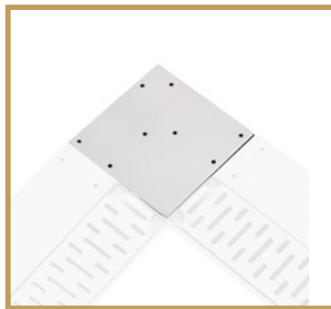

UBDR-90-IC

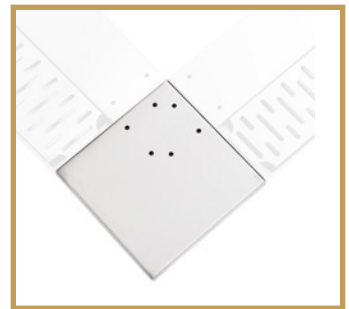

UBDR-90-OC

### ACCESSORIES

MODEL	DESCRIPTION
UBDR-45-IC	45 Degree Inside Corner Filler
UBDR-45-OC	45 Degree Outside Corner Filler
UBDR-90-IC	90 Degree Inside Corner Filler
UBDR-90-OC	90 Degree Outside Corner Filler

### "UBDR" UNDERBAR BAR DRAIN

MODEL	SIZE (L X W X H)	WEIGHT (LBS)
UBDR-12	12"x8"x3/4"	3
UBDR-18	18"x8"x3/4"	4
UBDR-24	24"x8"x3/4"	5
UBDR-30	30"x8"x3/4"	7
UBDR-36	36"x8"x3/4"	8
UBDR-42	42"x8"x3/4"	9
UBDR-48	48"x8"x3/4"	10

ALL DIMENSIONS ARE TYPICAL. TOLERANCE +/- .500". JOHN BOOS & CO. RESERVES THE RIGHT TO CHANGE SPECIFICATIONS WITHOUT NOTICE.

# DETAILED SPECIFICATIONS

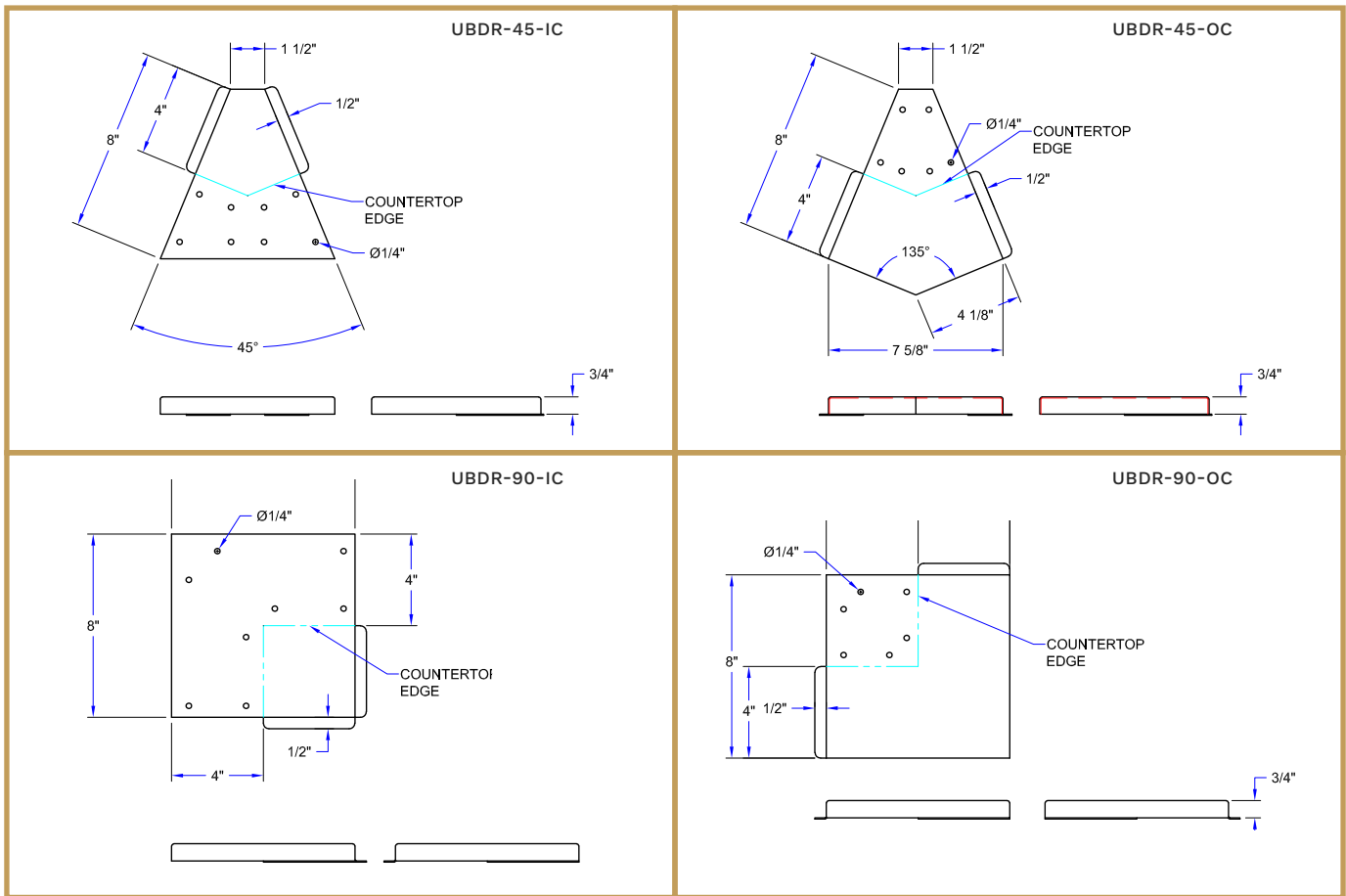
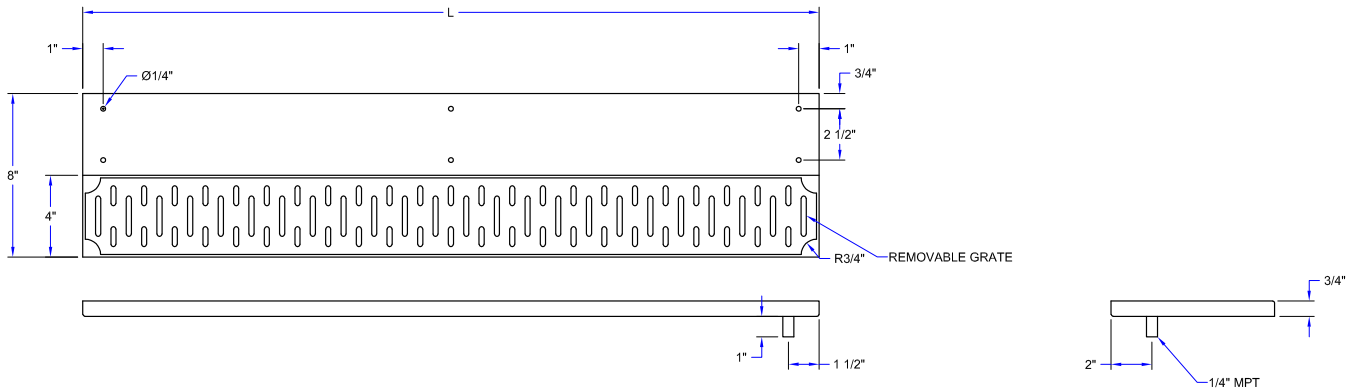

## "UBDR" UNDERBAR BAR DRAIN

MODEL	SIZE (L X W X H)	WEIGHT (LBS)
UBDR-12	12"x8"x3/4"	3
UBDR-18	18"x8"x3/4"	4
UBDR-24	24"x8"x3/4"	5
UBDR-30	30"x8"x3/4"	7
UBDR-36	36"x8"x3/4"	8
UBDR-42	42"x8"x3/4"	9
UBDR-48	48"x8"x3/4"	10

ALL DIMENSIONS ARE TYPICAL. TOLERANCE +/- .500". JOHN BOOS & CO. RESERVES THE RIGHT TO CHANGE SPECIFICATIONS WITHOUT NOTICE.