

The Hub Buffet System

Introducing THE HUB. Simplicity and innovation, like never before; a magical buffet for both indoor and outdoor venues. At Eastern, we like to keep things simple. We work complex innovations into quality, yet easy-to-use products that are a delight to operate. The Hub is the newest add-on to our popular Rolling Buffets, a complement to Eastern's extensive line of chafing dishes and quality buffetware.

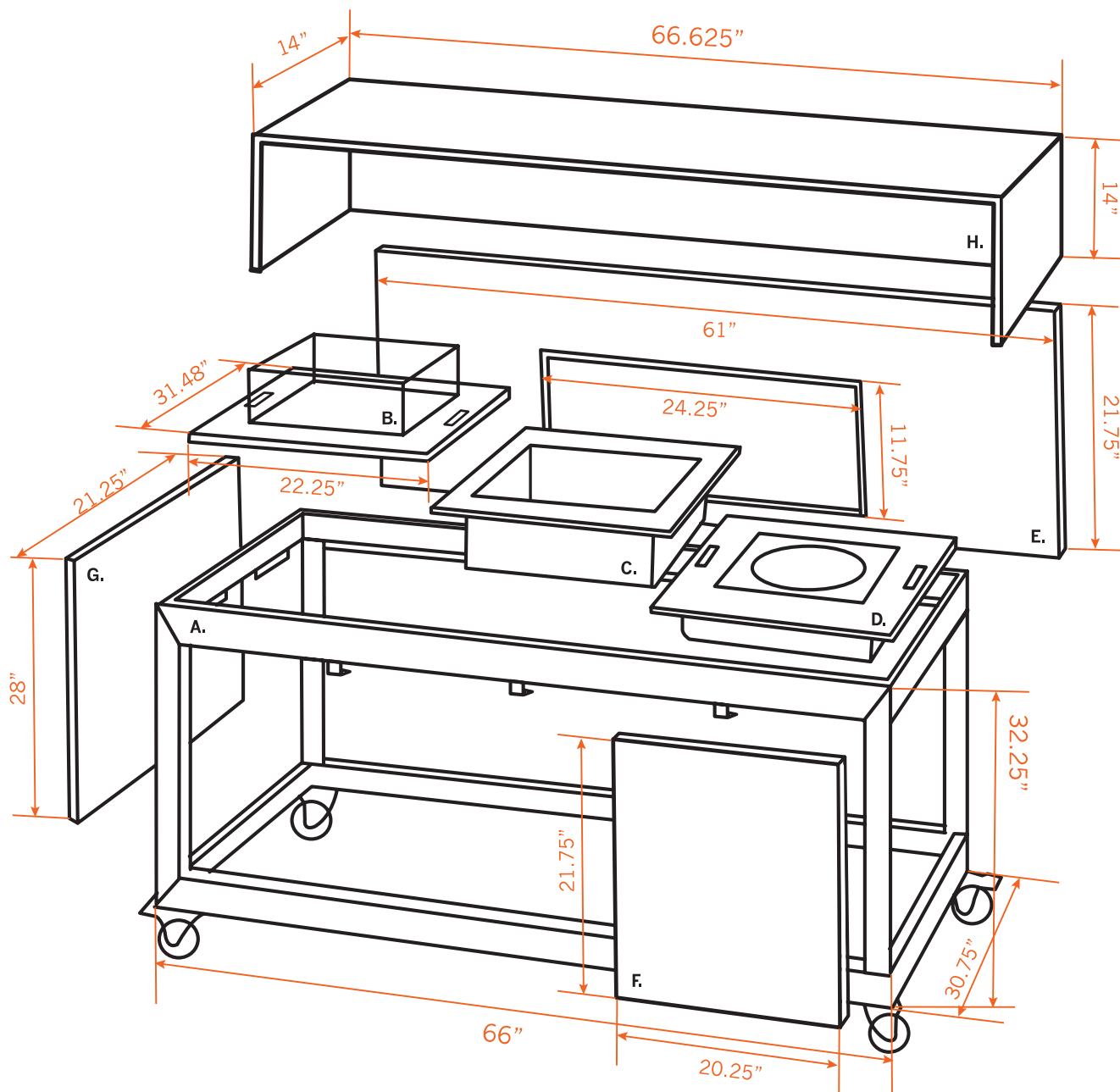

If you would like to receive our full catalog, simply send us an email at sales@easterntabletop.com.

A. Table Frame 66" length, 30.7" width, 32.25" height, 100lbs
#ST5900 Brushed Stainless Steel | **#ST5900MB** Black XYLO Coated
#ST5900RZB Bronze XYLO Coated | **#ST5900CP** Copper XYLO Coated

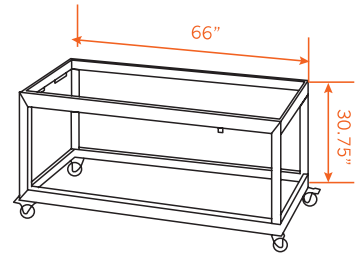

B. Built-up Ice Bin Tile 31.48" length, 22.25" width, .75" height, 50lbs
#ST5930BIB 34lbs Capacity ICE BIN: 5.5" front height, 6.5" back height

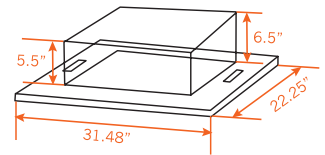

C. Drop-in Sink Tile 31.48" length, 22.25" width, .75" height, 8.5" deep, 55lbs
#ST5925DIB 84lbs Capacity | Double wall insulated stainless steel

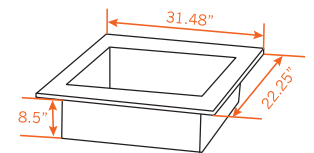

D. Induction Tile 31.48" length, 22.25" width, .75" height, 35lbs | IND: 15.25 length, 11.75 width
#ST5915IND Grey Grain | **#ST5917BIND** Black 110V 50/60hz 1500 Watts

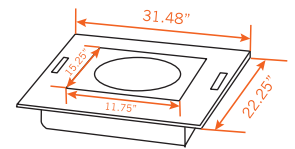

E. Front Panel 61" length, 21.75" width, 35lbs | WINDOW: 24.25" length, 11.75" width
#ST5910F Textured Laminate | **#ST5912BKF** Black Laminate

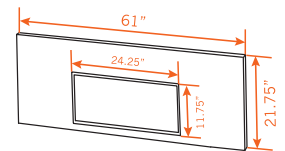

F. Front Panel 21.75" length, 20.25" width, 13lbs
#ST5966TF Textured Laminate | **#ST5963BF** Black Laminate
#ST5962SF Brushed Stainless Steel | **#ST5903GF** Grey Grain
#ST5961LEDF LED | **#ST5960ACF** Optic Reflector Acrylic

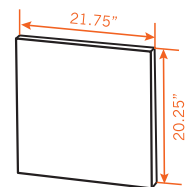

G. Side Panels 28" length, 21.25" width, 15lbs
#ST5909S Textured Laminate | **#ST5908BKS** Black Laminate
#ST5906S Brushed Stainless Steel | **#ST5903GS** Grey Grain
#ST5904LEDS LED | **#ST5907ACS** Optic Reflector Acrylic

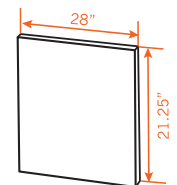

H. Bar Top 66.625" length, 14" width, 14" height, 35lbs
#ST5950BL Textured Laminate | **#ST5950BAC** Optic Reflector Acrylic
#ST5950BLSS Brushed Stainless Steel

